

## 25 MEGALIA LED (36-LED)

### Construction:

The unit consist of a body (1). A shade (2) is mounted to the luminary body with a ring (3). A disk (4) separating electrical compartment from lighting compartment, is attached to a luminary body. A LED light sources radiator (6) is settled to the disk (4). LED modules (5) are mounted to the radiator (6) with a set of lenses, by screws. The modules are powered with a power supply (7). The luminary is sealed with a gasket (8). As an option, we equip the luminary with a ZHAGA socket (11)

### Mounting instructions:

- \*) - Screw the LED light sources(5) with a lenses to the radiator (6).
- \*) - Connect the electrical cables according to the scheme.
- Tighten bolts to mount a disk (4) to the luminary body (1).
- Mount the shade (2) to the body (1) with a ring (3). Tighten mounting bolts.
- The luminary is mounted to the lantern with a M20 thread (10) (hanged luminary).

If any lantern elements are supplied factory-mounted, the mounting stages marked with \*) should be omitted (as this has already been done by the manufacturer).

### Technical data:



- Power: **~220-240V / 50-60Hz**
- Ambient/work temperature : **-30°C do +35°C**
- Protective class: **I**
- Ingress protection code: **IP66**
- Mechanical impact protection code: **IK10**
- Surge protection: **to 10kV**
- Life time: **L90, B10 >100 000h**
- Controls method: **1-10V, DALI, Ampdim, Dynadimmer,**  
as an option - **socked ZHAGA with SR driver (D4i),**

### Application:

**Lighting: roadways, pavements, bicycle paths, markets, parks, parkings, pedestrian crossings**

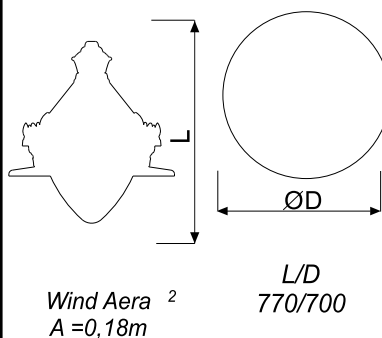

### Product equipped with a replaceable light source LED - options:

Product Symbol	Light source	Luminous flux [lm]			Pn [W]	If [mA]	Weight [kg]	Luminary dimensions	
		2700K (827)	3000K (830)	4000K (840)					
25 L-36W	36-LED G5	4050	4635	4907	36	300	13,5		
25 L-47W	36-LED G5	5409	6026	6371	47	400	13,5		
25 L-58W	36-LED G5	6426	7362	7784	58	500	13,5		
25 L-69W	36-LED G5	7554	8652	9747	69	600	13,5		
25 L-80W	36-LED G5	8640	9900	10469	80	700	13,5		
25 L-92W	36-LED G5	9702	11114	11751	92	800	13,5		

Luminous flux values shall be declared for ambient temperature 25°C. The class of modules used assumes 5% tolerance of the declared luminous flux value. The weight of the unit may slightly differ for individual production batches.

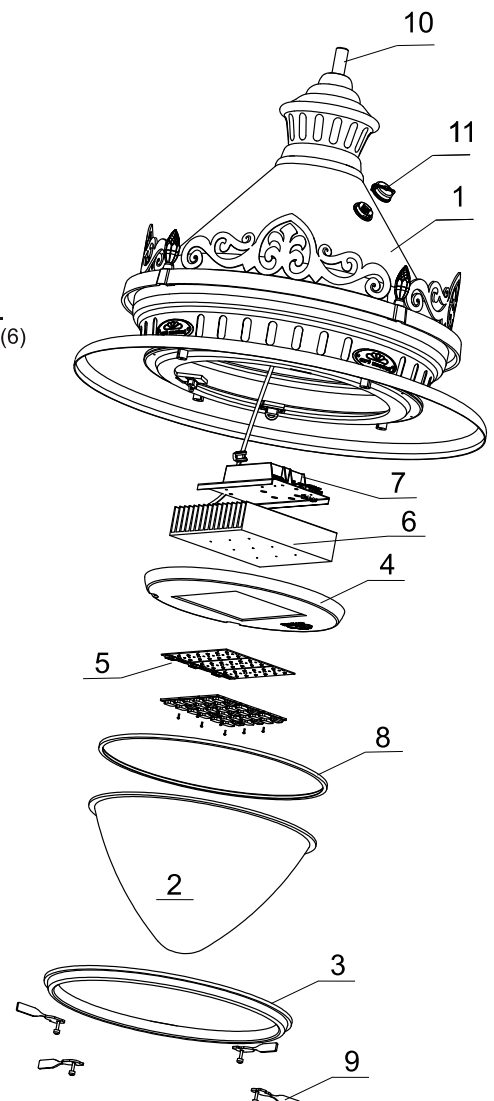

# 25 MEGALIA LED (36-LED)

## Available lenses - Photometry (polar plot) :

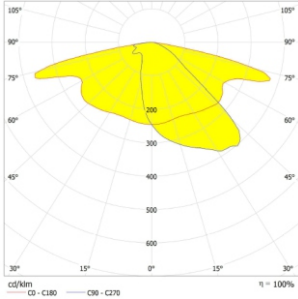

1. Basic lens ME

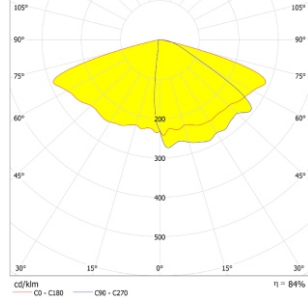

2. As an option lens T3

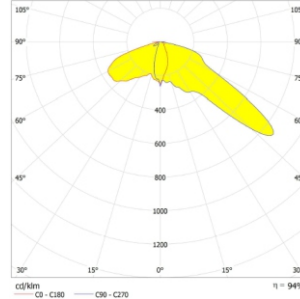

3. As an option lens PX

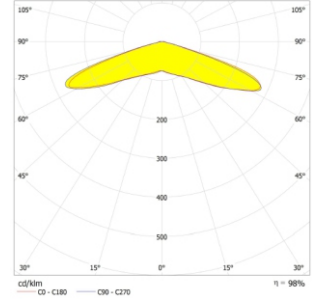

4. As an option lens VSM

## Versions/assembling:

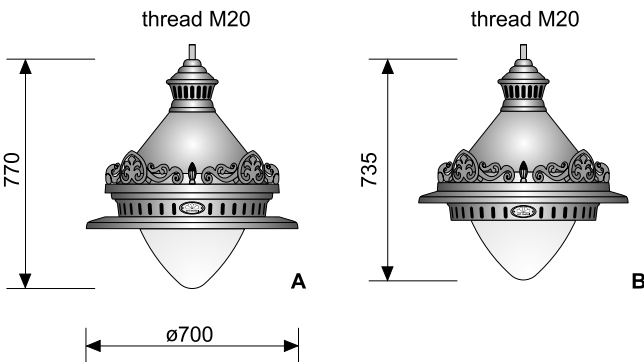

## Electrical diagrams:

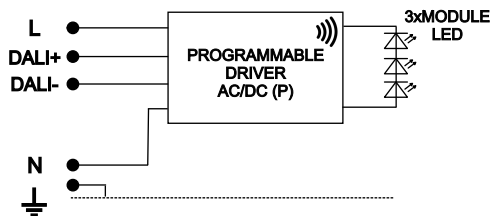

1. Light source LED  
 (basic version - programmable driver)

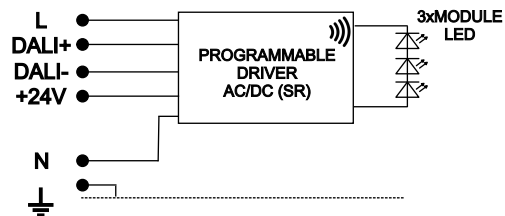

2. Light source LED  
 (version as an option - Sensor Ready driver)

- programmable driver (P) enables programming of a five-steps power reduction, surge protection to 10kV
- programmable driver (SR) enables to be powered wireless communication devices, via a ZHAGA socket, surge protection to 10kV
- detailed specifications of the power supplies include catalogue cards of their manufacturers, which we provide on request