

29 TECHNO LED (36-LED)

Construction:

The unit consists of a body (1) closed on the top with a bonnet (2) with hinge. Tools are not necessary, to open a luminaire unfasten buckles (3). The body is mounted to the pole with adjustable joint (4) which enables to regulate its position. Optical part of the luminaire with LED modules (5) and lenses (6) is tightly closed by shade (7) with a frame (8). Power supply (9) is placed in a separate, hermetic compartment. The tightness of the luminaire ensure theseals (10). As an option, we equip the luminaire with a ZHAGA socket (11)

Mounting instructions:

- Lead the cable through the joint and place a luminaire on the pole or arm (diameter $\varnothing 60\text{-}\varnothing 76\text{ mm}$)

- *) - Make electrical connections in accordance with the markings. Tighten the cable glands.
- Close the bonnet (2), fasten to the body (1) with buckles (3).
- Angle of the luminaire is regulated with a scale on the joint (4). Tighten the screws to block it on the correct position.

If any lantern elements are supplied factory-mounted, the mounting stages marked with *) should be omitted (as this has already been done by the manufacturer).

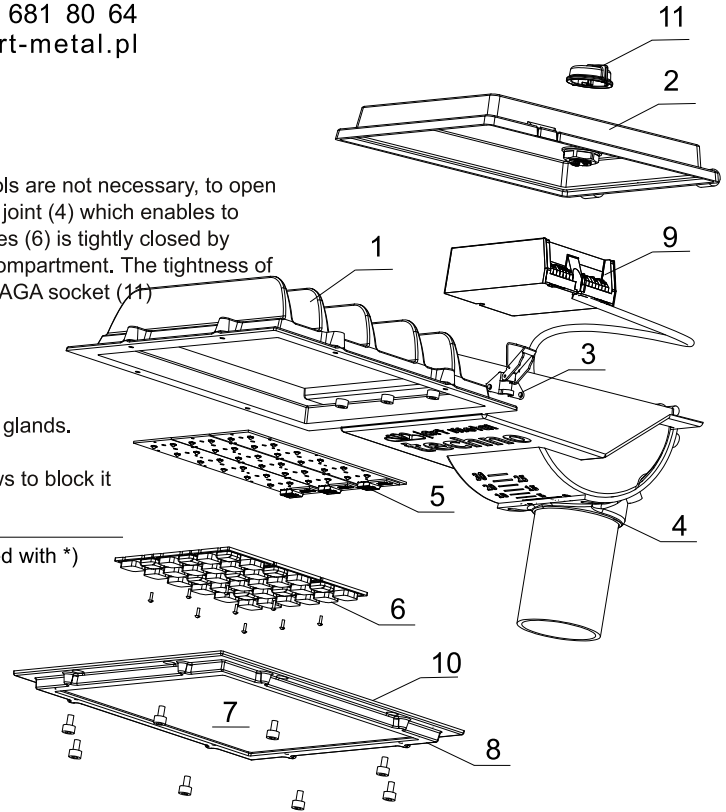

Technical data:

- Power: **~220-240V / 50-60Hz**
- Ambient/work temperature : **-30°C do +35°C**
- Protective class: **I**
- Ingress protection code: **IP66**
- Mechanical impact protection code: **IK10**
- Surge protection: **to 10kV**
- Life time: **L90, B10 >100 000h**
- Controls method: **1-10V, DALI, Ampdim, Dynadimmer,**
as an option - **socked ZHAGA with SR driver (D4i),**

Application:

Lighting: roadways, pavements, bicycle paths, markets, parks, parkings, pedestrian crossings



Product equipped with a replaceable light source LED - options:

Product Symbol	Light source	Luminous flux [lm]			Pn [W]	If [mA]	Weight [kg]	Luminaire dimensions
		2700K (827)	3000K (830)	4000K (840)				
29 L-36W	36-LED G5	4403	4635	4907	36	300	5,5	 Wind area $A = 0,14\text{m}^2$ L/W/H 495/275/210
29 L-47W	36-LED G5	5725	6026	6371	47	400	5,5	
29 L-58W	36-LED G5	6994	7362	7784	58	500	5,5	
29 L-69W	36-LED G5	8219	8652	9747	69	600	5,5	
29 L-80W	36-LED G5	9405	9900	10469	80	700	5,5	
29 L-92W	36-LED G5	10558	11114	11751	92	800	5,5	
29 L-97W	36-LED G5	11285	11833	12512	97	850	5,5	

Luminous flux values shall be declared for ambient temperature 25°C. The class of modules used assumes 5% tolerance of the declared luminous flux value. The weight of the unit may slightly differ for individual production batches.

06 ANDROMEDA LED (36-LED)

Available lenses - *Photometry (polar plot) :*

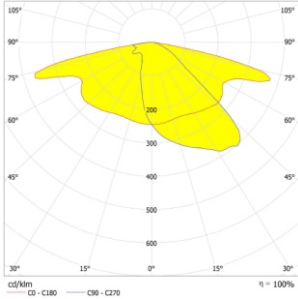

1. Basic lens ME

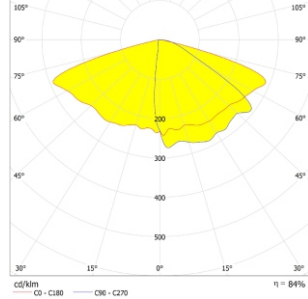

2. As an option lens T3

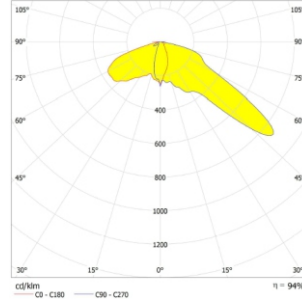

3. As an option lens PX

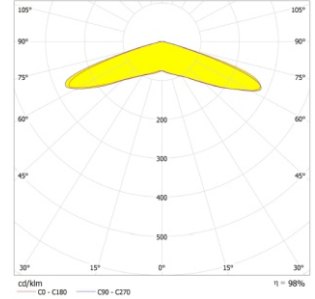

4. As an option lens VSM

Versions/assembling:

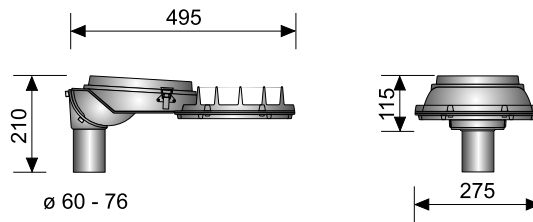

Electrical diagrams:

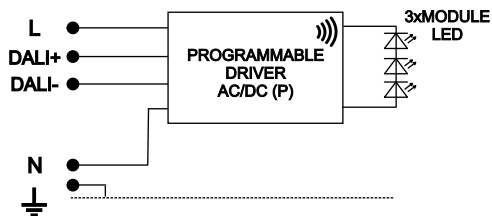

1. Light source LED
 (basic version - programmable driver)

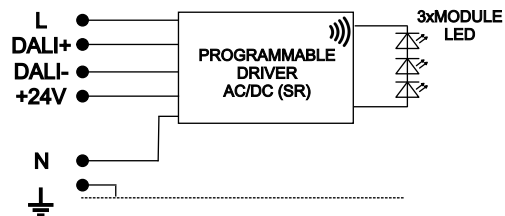

2. Light source LED
 (version as an option - Sensor Ready driver)

-programmable driver (P) enables programming of a five-steps power reduction, surge protection to 10kV

-programmable driver (SR) enables to be powered wireless communication devices, via a ZHAGA socket, surge protection to 10kV

-detailed specifications of the power supplies include catalogue cards of their manufacturers, which we provide on request