



art metal

15 NEPTUN

F.P.H. Art Metal Sp.j.

Ul. Jabłoniowa 124, 83-331 Łapino Kartuskie, Poland
Tel. 0048 58 681 80 78, Fax: 0048 58 681 80 64
www.art-metal.pl e-mail: biuro@art-metal.pl

Construction:

The unit consists of an aluminium lamp body (1) with a reflector (2) and ceramic lampholder (3) mounted to the supporting frame (4). There is a bulb (5) placed in a lampholder. There is a pane (6) and an opalescent ring (7) mounted to the lamp body. The pane is mounted with a flange (8) which is screwed to the lamp body. There is an isolating panel (9), igniter module (10) and a connection with an electric network. The lamp body is finished with a dome (11), mounted with bolts to the lamp body. Tightness is provided by gaskets placed between the dome and the lamp body and between the pane and the lamp body (12).

Mounting instructions:

- *) -Mount the igniter module inside the lamp body.
- *) -Mount the reflector and the lampholder to supporting frame, mount in the lamp body.
- Make a connection, close the lantern dome.
- Fix the ring gaskets, pane and the gaskets - screw with bolts.

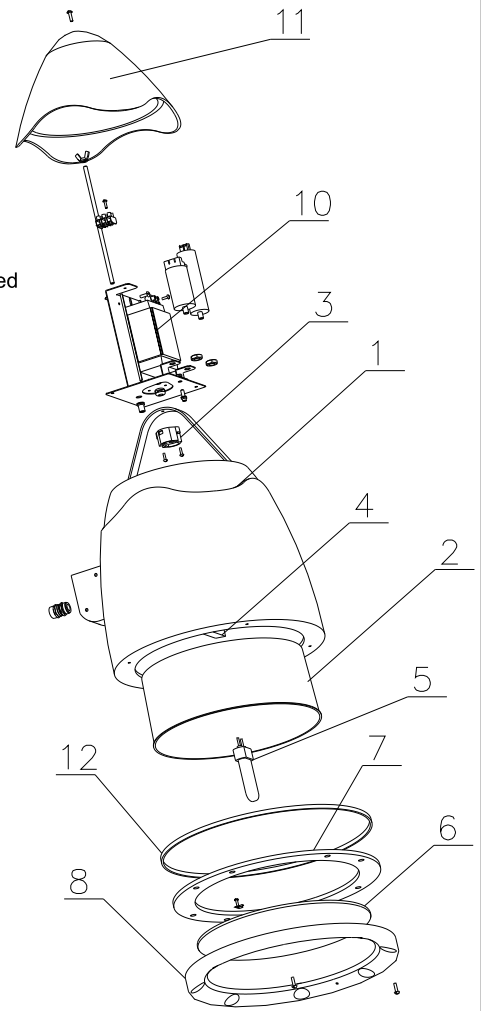

If any lantern elements are supplied factory-mounted, the mounting stages marked with *) should be omitted (as this has already been done by the manufacturer)

TECHNICAL DATA:

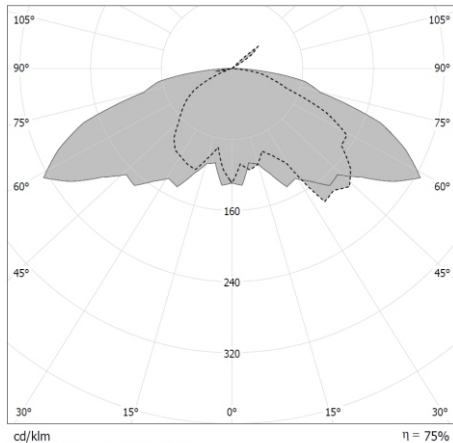

Photometry (polar plot)

Power: ~230/50Hz

Protective class: I

IP66 -electrical part

IP66 -optical part

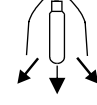
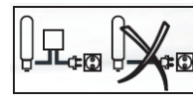
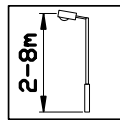

ELECTRICAL DIAGRAM:

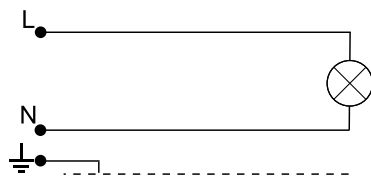

1. Incandescent bulb

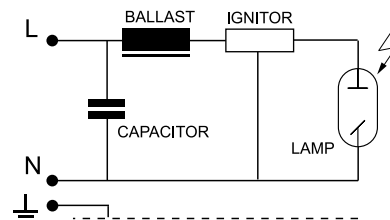

2. Sodium / metal halide lamps

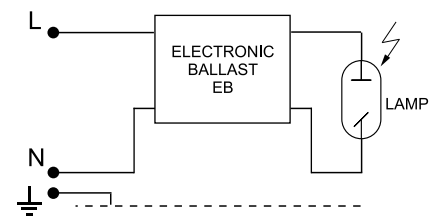

3. Sodium / metal halide lamps

Type	Light-producing element	Lamp holder	Weight [kg]	Pn [W]		Luminary dimensions
				IC	EB	
15MH-70W	HCI-T/CDM-T	G12	8,2	81	78	
15Z-E/Z	Bulb / MINI-LINX	E/27	6,9	Max. 60		

WARNING !! The weight of the unit may slightly differ for individual production batches.

