



art metal

G02 MARS

F.P.H. Art Metal Sp.j.

Ul. Jabłoniowa 124, 83-331 Łapino Kartuskie, Poland
 Tel. 0048 58 681 80 78, Fax: 0048 58 681 80 64
 www.art-metal.pl e-mail: biuro@art-metal.pl

Construction:

The unit includes a basket (1) holding a shade (2). From the top, the basket and the shade are closed by the upper reflector (3) and the top cover (4) that is attached in place with the bolts. For regular bulbs a lampholder (5) is mounted in an additional arm at the bottom of the unit. For discharge bulbs, a tray (6) with a lampholder (5) and an igniter module (7) are attached to the upper reflector (3). A RASTER (ODB-3) reflector (8) can be mounted on the upper reflector (3) optionally. In either case, the lamp (9) is fitted to the lampholder (5). Gaskets (10) make the unit weather-tight.

Mounting instructions:

- *) -Attach the lampholder (5) and the igniter module (7) to the tray (6).
- *) -Fix the tray (6) to the upper reflector (3).
- Put the lamp (9) in position.
- Position the upper reflector (3) on the basket (1).
- Connect the igniter module (5) to the electrical terminals of the pole.
- Position the unit on the pole/arm.
- Tighten the bolts holding together the elements of the unit.

If any lantern elements are supplied factory-mounted, the mounting stages marked with *) should be omitted (as this has already been done by the manufacturer)

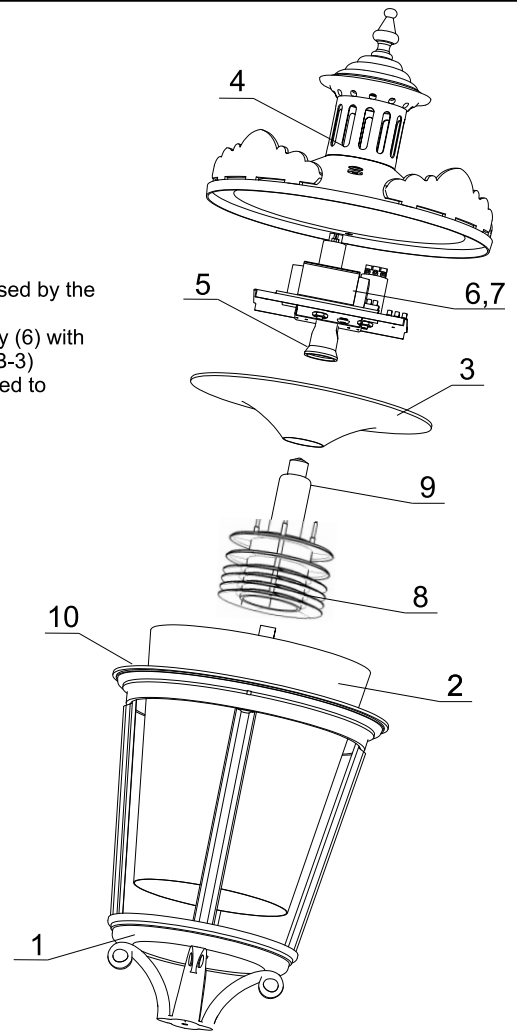

TECHNICAL DATA:

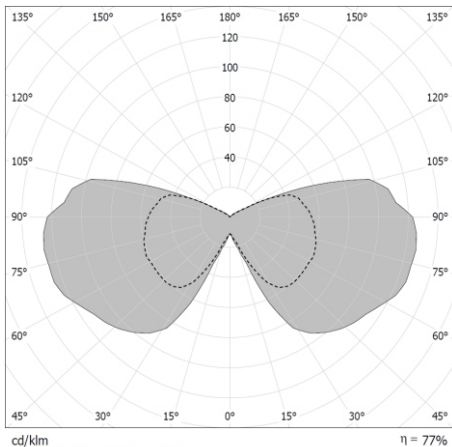

cd/klm
 C0 - C180 C90 - C270
 Photometry (polar plot)
 η = 77%

Power: ~230/50Hz

Protective class: I

IP65 -electrical part

IP65 -optical part

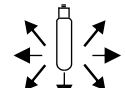
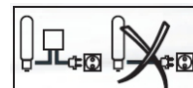
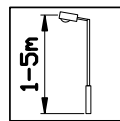

ELECTRICAL DIAGRAM:

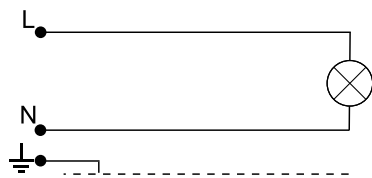

1. Incandescent bulb

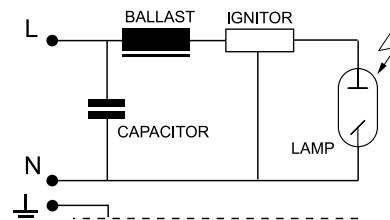

2. Sodium / metal halide lamps

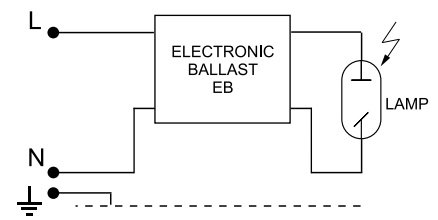

3. Sodium / metal halide lamps

Type	Light-producing element	Lamp holder	Weight [kg]	Pn [W]		Luminary dimensions
				IC	EB	
G02MH-70W	MH/HSI/HPI	E27	8,3	81	78	
G02MH-100W	MH/HSI/HPI	E27	8,4	114	109	
G02S-70W	WLS/SHP/SON	E27	8,3	81	78	
G02Z-E/Z	Bulb / MINI - LINX	E27	7,0	Max. 60		

WARNING !! The weight of the unit may slightly differ for individual production batches.

